

UVi-Aire 50G

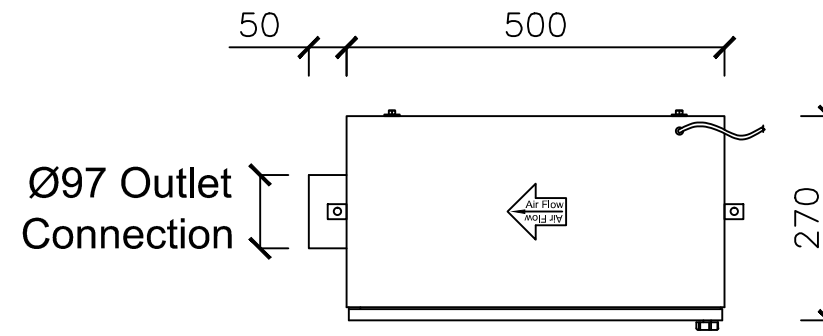

① **TOP VIEW**
Scale 1:10 @ A3

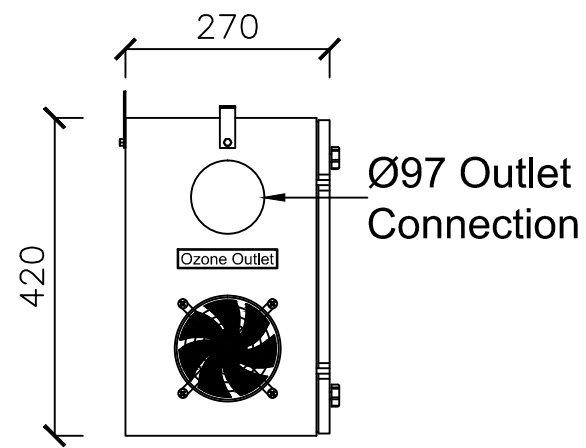

② **SIDE VIEW**
Scale 1:10 @ A3

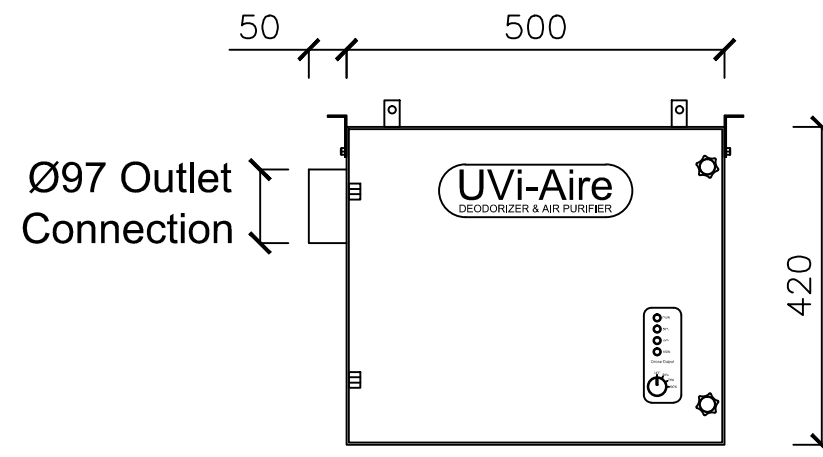

③ **FRONT VIEW**
Scale 1:10 @ A3

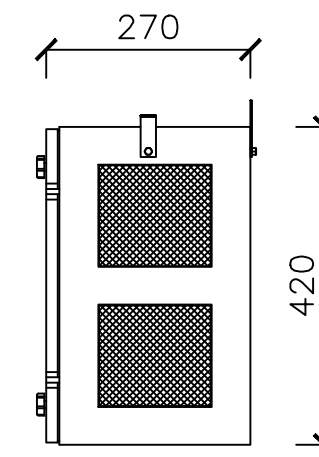

④ **SIDE VIEW**
Scale 1:10 @ A3

